

MODELS 5M1, 5M2, Ch.  
 HS-249; 5M1U, 5M2U,  
 Ch. HS-223

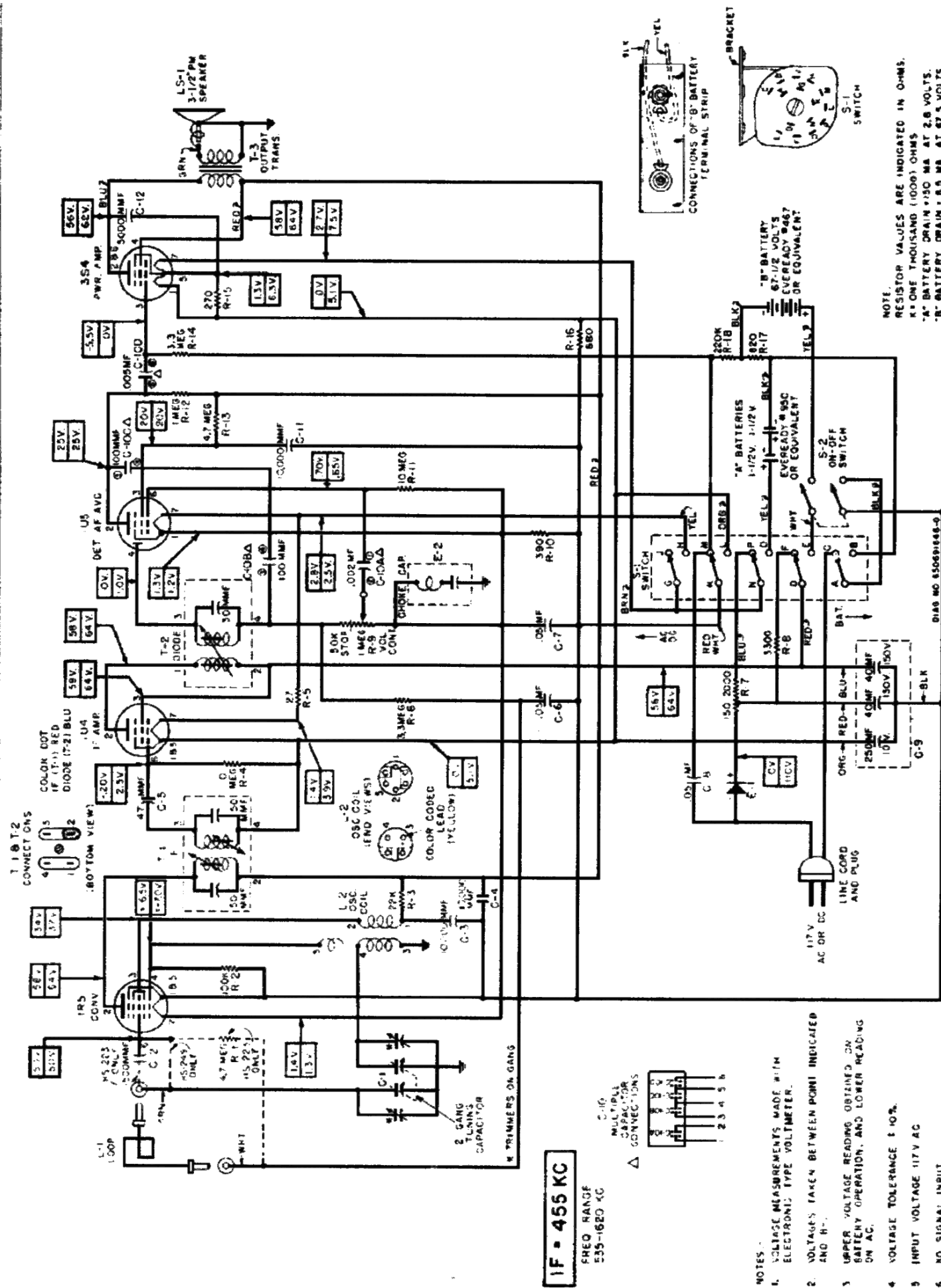
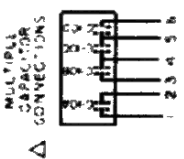

FIGURE 3. SCHEMATIC DIAGRAM, CHASSIS HS-223 & HS-249

- NOTES:
- VOLTAGE MEASUREMENTS MADE WITH ELECTRONIC TYPE VOLTMETER.
  - VOLTAGES TAKEN BETWEEN POINT INDICATED AND B-.
  - UPPER VOLTAGE READING OBTAINED ON BATTERY OPERATION, AND LOWER READING ON AC.
  - VOLTAGE TOLERANCE  $\pm 10\%$ .
  - INPUT VOLTAGE 117V AC
  - NO SIGNAL INPUT.
  - MEASUREMENT MADE WITH GANG FULLY OPEN.

**IF = 455 KC**  
 FREQ RANGE  
 535-1620 KC



NOTE:  
 RESISTOR VALUES ARE INDICATED IN OHMS.  
 K=ONE THOUSAND (1000) OHMS  
 M=BATTERY DRAIN=50 MA AT 2.6 VOLTS.  
 B=BATTERY DRAIN=6.5 MA AT 67.5 VOLTS

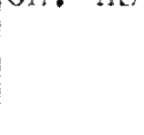
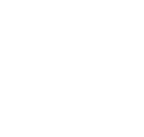
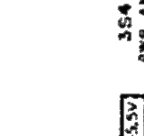
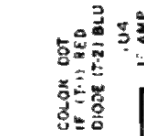
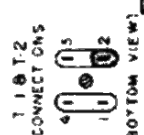
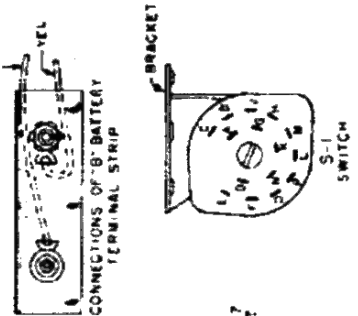

## GENERAL INFORMATION

**TYPE** - Three-power (AC/DC, Battery) portable radio receiver. Four miniature type tubes and a selenium rectifier are used in a superheterodyne circuit.

MODEL	COLOR	CHASSIS
5M1	Green	HS-249
5M1U	Green	HS-223
5M2	Maroon	HS-249
5M2U	Maroon	HS-223

**TUNING RANGE** - 535 to 1620 Kc      IF - 455 Kc

**TUBE COMPLEMENT** - 1R5 - Converter  
1R4 - IF Amplifier  
1U5 - Det, AVC & 1st AF Amp  
3S4 - Power Amplifier  
Rectifier - Selenium type - for AC/DC operation

**POWER SUPPLY** - Operates from 117V AC/DC (15 watts) or from the following batteries:

- 2 - 1½V flashlight cells (Eveready #950 or equivalent)
- 1 - 67½V "B" battery (Eveready #467 or equivalent)

5M1 & 5M2  
SERIES

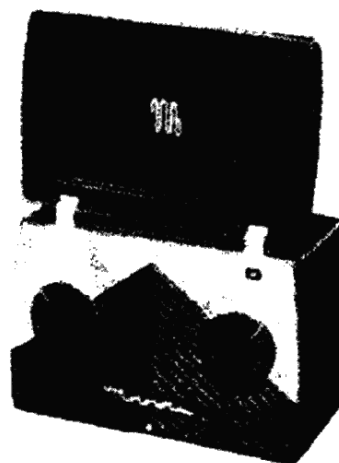

MODELS 5M1,  
5M2, Ch. HS-  
249; 5M1U,  
5M2U, Ch.  
HS-223

## OPERATING INSTRUCTIONS

**TO OPEN FRONT COVER.** The front cover is opened by pushing upward on the "M" bar located in the center of the cover. The receiver is automatically turned on when the front cover is opened and raised to a vertical position.

**TO OPEN BACK COVER.** The back cover may be opened by gently pulling it at the top. When closing the cover, be careful not to pinch the power line cord or other leads between the cover and the cabinet.

**117 VOLT AC OR DC OPERATION.** The power cord is located inside the cabinet and may be reached by opening the back cover. Pass the line cord through the slot on the side of the receiver, and plug it into any 117 volt AC or DC power outlet. If the receiver does not operate from DC power, reverse the plug in the power outlet. When operating from AC power, reception may sometimes be improved by reversing the power plug in the outlet. It is not necessary that batteries be installed if the receiver is to be operated only from house power lines.

**BATTERY OPERATION.** Open the back cover and install the batteries, following the instructions on the label inside the back cover (or see Figure 1). Insert the line cord plug into the receptacle on the chassis, or the receiver will not play from batteries. If the receiver is to be operated for a long period of time from 117 volts AC or DC, or is to be placed in storage, remove the batteries and store them in a cool place. **IMPORTANT:** Never leave low or run-down batteries in the receiver, as they will leak or swell and damage it.

**TUNING CONTROL.** Stations are tuned in with the right-hand knob. The markings around the tuning knob may be read in kilocycles by adding one zero to the figures.

**VOLUME CONTROL.** The left-hand knob controls volume.

**TO TURN OFF.** Closing the front cover will automatically turn off the receiver.

**ANTENNA.** A loop antenna is built into the front cover. Because of the slightly directional characteristics of the loop antenna, reception from some stations may be improved by rotating the entire receiver. In extremely noisy locations, rotate the receiver until minimum noise and maximum signal pickup are obtained.

**BATTERY REPLACEMENT.** If low volume or fuzzy tone is noticed when operating from batteries, replace the flashlight cells. Normally, the 67½V "B" battery will last for 3 or 4 changes of the flashlight cells. The condition of the batteries will not affect the operation of the receiver from 117 volts AC or DC. Complete battery replacement instructions will be found inside the cabinet back cover (or See Figure 1).

## SERVICE NOTES

The chassis of this receiver is isolated from the AC power line circuit by a capacitor-choke assembly to eliminate the shock hazard when handling the receiver. However, as an additional precaution when aligning or servicing the receiver from AC, an isolation transformer should be inserted between the power line and the chassis.

The tubes are exposed when the rear cover is opened. It is not necessary to remove the chassis to replace tubes.

To remove the chassis from the cabinet:

1. Pull off the two control knobs on the front of the cabinet.
2. Open the rear cover and remove the batteries.
3. Remove the two Phillips head screws holding the chassis to the cabinet ("A" - "A" in Figure 1).
4. Slide the chassis out of the cabinet.
5. Disconnect the two leads from the chassis to the loop antenna hinges.

MODELS 5M1, 5M2, Ch.  
HS-249; 5M1U, 5M2U,  
Ch. HS-223

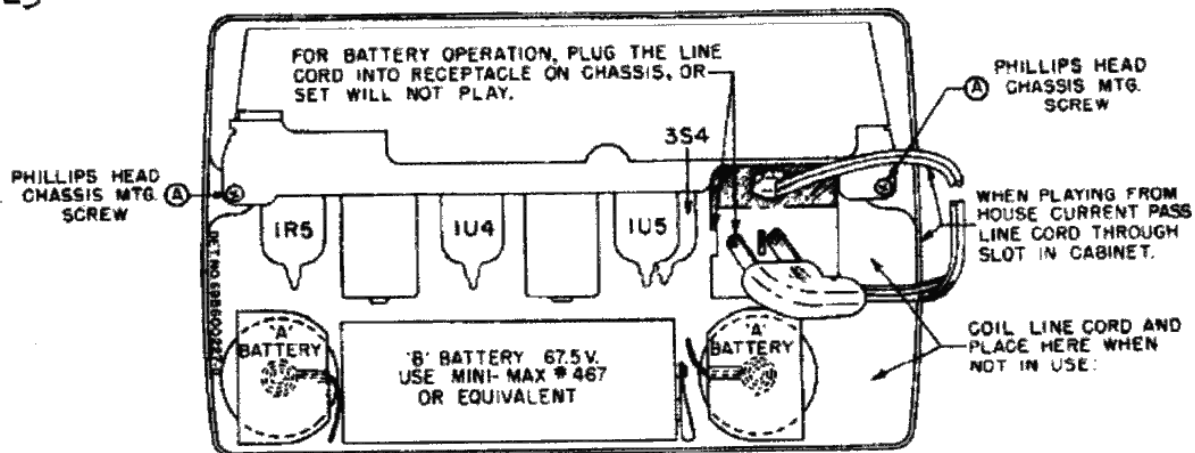

NOTE - 'A' BATTERIES: USE TWO 1-1/2V. FLASHLIGHT CELLS - EVEREADY #350 OR EQUIVALENT. INSTALL 'A' BATTERIES SO SPRING CONTACTS BOTTOM OF BATTERIES.

FIGURE 1. BATTERY INSTALLATION & CHASSIS REMOVAL INSTRUCTIONS

### ALIGNMENT CHART

STEP	DUMMY ANTENNA	GENERATOR CONNECTION	GENERATOR FREQUENCY	GANG SETTING	ADJUST	REMARKS
<b>IF ALIGNMENT</b>						
1.	.1 mf	Grid of conv (pin 6, IR5)*	455 Kc	Fully open	1, 2 & 3	Adjust for maximum.
<b>RF ALIGNMENT</b>						
2.	-	Grid of conv (pin 6, IR5)*	1620 Kc	Fully open	4	Adjust for maximum.
3.	-	-	-	-	-	Install chassis in cabinet, leaving output meter connected to speaker.
4.	-	Radiation loop**	1400 Kc	Tune for maximum	5	Adjust for maximum. Trimmer is reached through hole under plug button on side of cabinet.

\* On chassis HS-249 return the grid of the converter tube to AVC either through the loop or through a 4.7 meg resistor (as in chassis HS-223).

\*\*Connect generator output across 5" diameter, 5 turn loop and couple inductively to receiver loop. Keep loops at least 12" apart.

### ALIGNMENT

NOTE: The receiver may be operated either from a battery or from the commercial power lines during alignment. If AC power is used, it is recommended that an isolation transformer be placed between the power line and the receiver. If an isolation transformer is not available, connect the low side of the signal generator to B- through a .1 mf capacitor.

1. Connect a low range output meter across the speaker voice coil.
2. Connect the low side of the signal generator to B-.
3. Set the signal generator for 400 cycle, 30%

modulation.

4. Turn the receiver volume control to maximum.
5. Use a small fibre screwdriver for aligning the IF and diode transformers.
6. As stages are brought into alignment, reduce the signal generator input to keep the output of the receiver at approximately .05 watt (.05 watt = .40 volts on the output meter) to avoid overloading the receiver.
7. See Figure 2 for adjustment locations and the following chart for procedure.

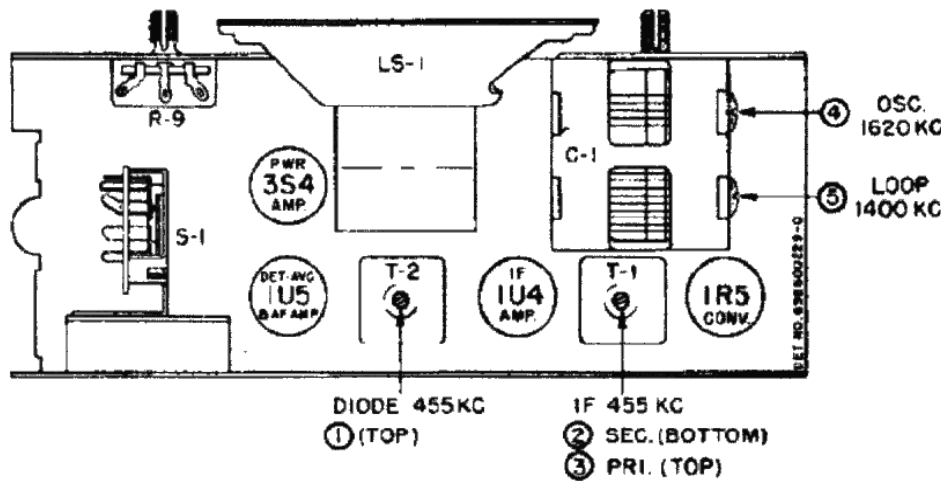

FIGURE 2. TUBE & TRIMMER LOCATIONS  
**REPLACEMENT PARTS LIST**

PART NUMBER	DESCRIPTION
4K470939	Washer, fibre (R-7 mtg) .....
<b>CABINET PARTS</b>	
7A600092	Bracket, escutcheon support: cad pl (cabinet front support)(5M1U & 5M2U)
38K692050	Button, plug; green finish (5M1 & 5M2U) .....
38K600106	Button, plug; maroon finish (5M2 & 5M2U)
1X692156	Cabinet: complete, less handle, grille and front cover; green finish (5M1 & 5M2U) .....
1X600126	Cabinet: complete, less handle, grille and front cover; maroon finish (5M2 & 5M2U) .....
42A600094	Clip, grille retainer (holds front grille to cabinet) .....
55A692058	Cover, handle mtg: brass plated (over ends of handle) .....
13D691949	Escutcheon, dial & volume (on front of cabinet) .....
55A27113	Foot, cabinet bottom: felt .....
1X692162	Front Cover Assembly: complete, less loop; green plastic (5M1 & 5M2U) .....
1X600131	Front Cover Assembly: complete, less loop; maroon plastic (5M2 & 5M2U) .....
1X692158	Grille Assembly: complete with escutcheon; green plastic (5M1 & 5M2U) .....
1X600128	Grille Assembly: complete with escutcheon; maroon plastic (5M2 & 5M2U) .....
55K692166	Handle, carrying: green plastic; less spring (5M1 & 5M2U) .....
55K600107	Handle, carrying: maroon plastic; less spring (5M2 & 5M2U) .....
55C692202	Hinge, front cover: complete; left-hand
55K600087	Hinge, front cover: complete; right-hand
55K30198	Hinge, rear cover
36B691899	Knob, control: green plastic (5M1 & 5M2U) .....
36K600105	Knob, control: maroon plastic (5M2 & 5M2U) .....
1X692163	Latch and Plate Assembly (inside front cover) .....
4S8406	Lockwasher, internal: #2; cad pl.
4S7683	Lockwasher, internal: #4; cad pl.
29R5399	Lug, soldering (under front hinge, for loop connection) .....
13B691901	Medallion (on front cover) .....
28A692198	Pin, loop connector (on front hinge) .....
64A692191	Plate, handle mtg: cad pl (under ends of handle) .....
5S8487	Rivet: .088 x 3/32 stl; blk nkl (rear cover hinges) .....
5S8490	Rivet: .088 x 5/32 stl; blk nkl (front hinge mtg)(5M1 & 5M2U) .....
5S2827	Rivet: .088 x 5/32 stl; statuary bronze (front hinge mtg)(5M2 & 5M2U) .....
3S490849	Screw, machine: 4-40 x 11/32 Phillips round head; cad pl (mounts front hinges to cabinet) .....
1S2995	Screw, machine: 5-40 x 5/16 plain hex head; cad pl (handle mtg) .....
3S490018	Screw, sheet metal: #2 x 1/4 PKZ Phillips flat head; blk nkl (mounts loop to front cover)(5M1 & 5M2U) .....
3S3389	Screw, sheet metal: #2 x 1/4 PKZ Phillips flat head; statuary bronze (mounts loop to front cover) (5M2 & 5M2U) .....
3S490739	Screw, sheet metal: #4 x 1/4 PKZ Phillips binderhead; cad pl (chassis mtg) .....
41A470909	Spring, door latch (inside front cover) .....
41K692167	Spring, handle (inside plastic handle)
41A692069	Spring, rear cover latch .....
42A692189	Scrap, door latch retainer (inside front cover) .....
46A692153	Stud, latch retainer (front cover latch, on grille) .....
46K690079	Stud, trimount: blk nkl (on loop panel for operating on-off switch)(5M1 & 5M2U) .....
46K680035	Stud, trimount: statuary bronze (on loop panel, for operating on-off switch)(5M2 & 5M2U) .....
4S1719	Washer, flat: 3/8 x .140 x .030 stl; cad pl (handle mtg) .....

REF. NO.	PART NO.	DESCRIPTION
<b>CHASSIS PARTS - ELECTRICAL</b>		
<b>CAPACITORS</b>		
C-1	19K692007	Variable, 2-gang .....
C-2	21K481377	Ceramic, disc type: 500 mfd 500V .....
C-3	21K482726	Ceramic, disc type: 10,000 mfd 450V .....
C-4	21K482726	Ceramic, disc type: 10,000 mfd 450V .....
C-5	21K77371	Ceramic, disc type: 10,000 mfd 450V .....
C-6	8K71213	Paper: .05 mf 100V .....
C-7	8K71213	Paper: .05 mf 100V .....
C-8	8K471635	Paper: .05 mf 400V .....
C-9	23B691995	Electrolytic: 40-40 mf 150V/250 mf 10V .....
C-10A, B, C, D	21K691992	Ceramic, multiple: 2000 mfd, 100 mfd, 100 mfd, 5000 mfd .....
C-11	21K482726	Ceramic, disc type: 10,000 mfd 450V .....
C-12	21A470789	Ceramic, disc type: 3000 mfd 450V .....

REF. NO.	PART NO.	DESCRIPTION
R-16	6R6040	680 10% 1/4W .....
R-17	6R6269	820 10% 1/4W .....
R-18	6R6015	220.000 20% 1/4W .....

REF. NO.	PART NO.	DESCRIPTION
<b>CHASSIS PARTS - MECHANICAL</b>		
<b>SWITCHES</b>		
S-1	40B471927	Rotary switch, SPDT (AC/DC, battery selector) .....
S-2	40A691999	Slide switch (on-off) .....
<b>TRANSFORMERS</b>		
T-1	24B692014	IF Transformer, 455 Kc: complete with capacitors, less shield .....
T-2	24B692015	Diode Transformer, 455 Kc: complete with capacitors, less shield .....
T-3	25K692006	Output Transformer .....

REF. NO.	PART NO.	DESCRIPTION
<b>CHASSIS PARTS - MECHANICAL</b>		
43A692011	Bushing, insulator: fibre (on rear edge of chassis) .....	
43A692012	Bushing, strain relief: line cord (use with 43K692013) .....	
42K75826	Clip, electrolytic mtg .....	
42A485548	Clip, IF transformer mtg .....	
30B691994	Cord, line: with plug; 6 ft long (HS-223 only) .....	
30K600125	Cord, line: with plug; 6 ft long (HS-249 only) .....	
4S7650	Lockwasher, internal: #6; cad pl.	
29R5294	Lug, soldering (holds battery leads) .....	
29R5239	Lug, soldering: #8 hole (holds line cord) (HS-223 only) .....	
29R3020	Lug, soldering: battery contact (in 'A' battery retainer) .....	
2S7005	Nut, hex: 6-32 x 1/4 stl; cad pl (R-7 & selenium rect mtg) .....	
2S7051	Nut, hex: palnut; 3/8-32 x 9/16; cad pl (volume control mtg) .....	
9A470980	Receptacle, loop (on lead to loop) .....	
15B481896	Retainer, 'A' battery: plastic .....	
43K692013	Retainer, strain relief (on line cord bushing) (use with 43A692012) .....	
5S7771	Rivet: .088 x 3/16 stl; nkl pl (tube socket mtg) .....	
5S7706	Rivet: .122 x 1/8 stl; nkl pl (term strip & switch mtg) .....	
3S490828	Screw, machine: 6-32 x 3/16 plain hex head lockcrew; cad pl (gang mtg) .....	
3S7363	Screw, machine: 6-32 x 1 slotted binderhead; cad pl (selenium rect mtg) .....	
3S1451	Screw, machine: 6-32 x 2 slotted round head; cad pl (R-7 mtg) .....	
3S7205	Screw, machine: 8-32 x 1/4 slotted hex head lockcrew; cad pl (sprk mtg) .....	
3S2695	Screw, sheet metal: #6 x 3/16 PKZ pl hex head; cad pl (rear shield mtg) .....	
3S7462	Screw, thread-cutting: 6-32 x 3/16 plain hex head; cad pl (S-1 mtg) .....	
26K692003	Shield, back (on rear of chassis) .....	
26A692005	Shield, heat (around R-7) .....	
26K691997	Shield, switch (over AC/DC, Batt. sw) .....	
9A690129	Socket, tube: miniature; 7-prong .....	
41K680029	Spring, battery contact (in 'A' battery retainer) .....	
31K470880	Strip, 'B' battery terminal: with leads .....	
31K37504	Strip, terminal: 1 insulated lug; #1 mtg; 3/8" spacing .....	
31K470746	Strip, terminal: 3 insulated lugs; #2 mtg; 3/8" spacing .....	

REF. NO.	PART NO.	DESCRIPTION
<b>CHOKES &amp; CAPACITOR</b>		
E-2	24K691986	Choke & .05 mf 200V paper capacitor .....
<b>RECTIFIER</b>		
R-1	48H91092	Selenium Rectifier: half-wave .....
<b>COILS</b>		
L-1	1X692159	Antenna Loop & Front Cover Assembly: complete; green plastic (5M1 & 5M2U) .....
	1X692160	Antenna Loop, Panel & Hinge Assembly: less front cover; green plastic (5M1 & 5M2U) .....
	24K692200	Antenna Loop & Panel Assembly: less hinges; green plastic (5M1 & 5M2U) .....
	1X600129	Antenna Loop & Front Cover Assembly: complete; maroon plastic (5M2 & 5M2U) .....
	1X600130	Antenna Loop, Panel & Hinge Assembly: less front cover; maroon plastic (5M2 & 5M2U) .....
	24K600132	Antenna Loop & Panel Assembly: less hinges; maroon plastic (5M2 & 5M2U) .....
L-2	24K600097	Oscillator Coil (yellow code)
<b>SPEAKER</b>		
LS-1	50K600142	Speaker: 3/4" PM; 3.2 ohm VC.
or	50K600141	Speaker: 3/4" PM; 3.2 ohm VC.
<b>RESISTORS</b>		

REF. NO.	PART NO.	DESCRIPTION
R-2	6R6031	100,000 10% 1/4W .....
R-3	6R6397	22,000 10% 1/4W .....
R-4	6R2109	10 meg 20% 1/4W .....
R-5	6R5683	27 10% 1/4W .....
R-6	6R2118	3.3 meg 20% 1/4W .....
R-7	17K692009	Wire wound: 2150 5% 10W; tapped
R-8	6R5581	3300 10% 1/4W .....
R-9	18A691993	Volume control: 1 megohm .....
R-10	6R5554	390 10% 1/4W .....
R-11	6R2109	10 meg 20% 1/4W .....
R-12	6R6004	1 meg 20% 1/4W .....
R-13	6R2122	4.7 meg 20% 1/4W .....
R-14	6R2118	3.3 meg 20% 1/4W .....
R-15	6R6432	270 10% 1/4W .....

Note: All resistors are insulated, carbon type unless otherwise specified.

31K470880 Strip, 'B' battery terminal: with leads  
31K37504 Strip, terminal: 1 insulated lug; #1 mtg; 3/8" spacing  
31K470746 Strip, terminal: 3 insulated lugs; #2 mtg; 3/8" spacing