

EF 41

EF 41 Variable-mu R.F. pentode

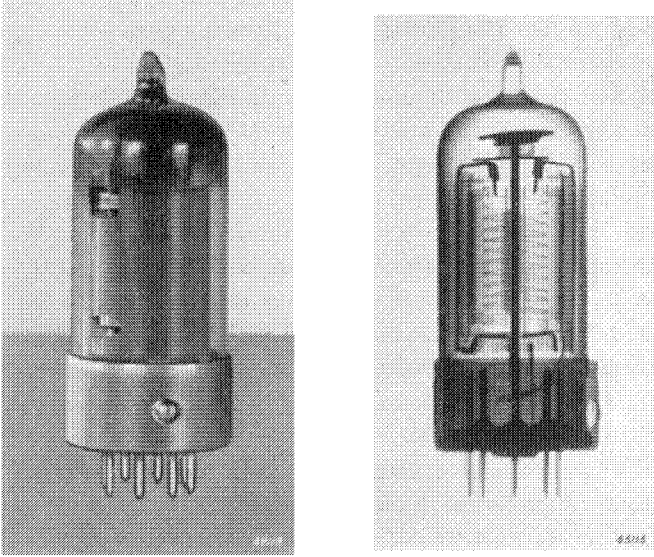

Fig. 1
Normal and X-ray photographs of the EF 41 (approximately actual size).

The EF 41 is a variable-mu pentode suitable for R.F. and I.F. amplification in A.C. receivers and car-radio sets. The slope, in the absence of control, is 2.2 mA/V and the internal resistance 1.1 M Ω .

The excellent properties of this valve from the point of view of cross-modulation when gain control is applied are most apparent when a sliding screen grid voltage is employed, a series resistance of 90 k Ω being included in the screen grid circuit. In the uncontrolled condition, with a grid bias of -2.5 V, the screen grid potential is 100 V in that case; with a bias of -39 V, the mutual conductance is reduced to 1/100th of its original value.

As in the EAF 42, the entire electrode system is enclosed in a metal shield inside the envelope, so that no external screening is needed. The anode and control grid lead-in wires are also carefully screened, so that the grid-to-anode capacitance is at most 0.002 pF and the risk of undesirable feedback from the anode to the control grid circuit is reduced to a minimum. Nevertheless, it is still essential to press the valve well home in its holder and to bend the lugs on the raised metal edge of the valveholder slightly inwards (the reasons for these measures are given in the description of the EAF 42). Used as an I.F. amplifying valve, the EF 41 is found chiefly in sets employing the EBC 41 as A.F. amplifier. Two separate diodes are then available for detection and A.G.C. This offers special advantages in all cases where delayed A.G.C. is required.

In view of the fact that the EF 41 is usually employed as I.F. amplifier in conjunction with an A.F. stage, the reserve gain is sufficient to allow the diodes and anode of the pentode to be connected to tappings on the I.F. coils, for greater selectivity. If such tappings are provided at points equal to 7/10ths of the coil, and if the quality factor of the coils $Q=140$, an I.F. amplification of about 120 will be obtained.

As an R.F. amplifying valve, the EF 41 is particularly suitable for receivers in which a good short-wave reception is required. Owing to the small quality factor of the tuned short-wave circuits the sensitivity will be smaller than at longer wavelengths and the signal-to-noise ratio less favourable. Naturally, such a higher amplification can also be obtained by means of an extra I.F. stage, but in that case the signal-to-noise ratio is governed by the noise produced by the frequency changer, which is some 10 times more pronounced than that due to the R.F. valve. This explains why a short-wave receiver often includes an R.F. stage, despite the fact that this arrangement is more complicated than an extra I.F. stage.

In view of its small size, the EF 41 — like all Rimlock type valves — is an excellent valve for car radio, where space is relatively limited.

In common with the EAF 42, the screen grid of the EF 41 can be fed from the same source as the screen grids of the frequency changer (ECH 41 or ECH 42); see Fig. 2.

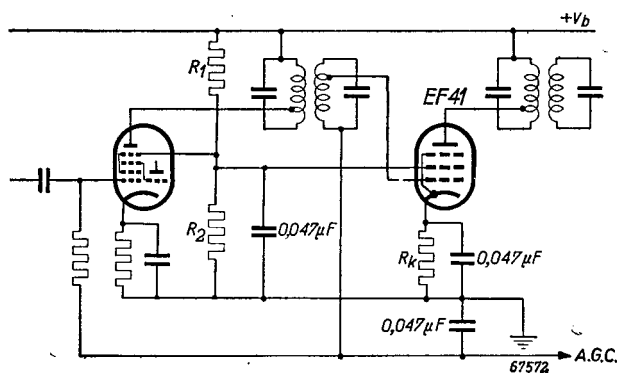

Fig. 2

The EF 41 used as I.F. amplifier, with screen grid voltage derived from the same potentiometer as that which is used to feed the screen grids of the frequency changer.

EF 41

TECHNICAL DATA OF THE R.F. PENTODE EF 41

Heater data

Heating: indirect, A.C. or D.C., parallel feed

Heater voltage	V_f	=	6.3 V
Heater current	I_f	=	0.2 A

Capacitances (cold valve)

Input capacitance	C_{g1}	=	5.3 pF
Output capacitance	C_a	=	5.9 pF
Anode - control grid	C_{ag1}	<	0.002 pF
Heater - control grid	C_{gf}	<	0.1 pF

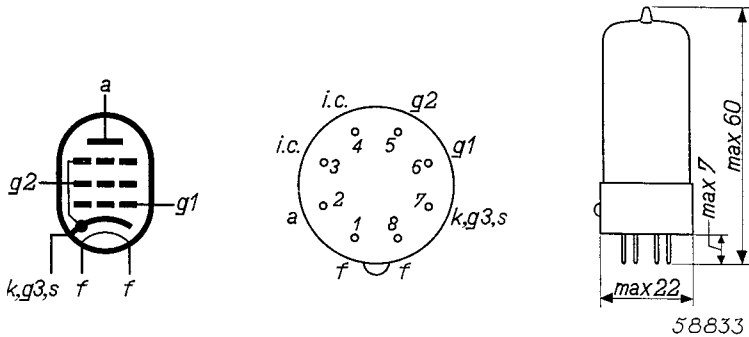

Fig. 3

Electrode arrangement, electrode connections and maximum dimensions (in mm) of the EF 41.

Operating characteristics of the EF 41 used as R.F. or I.F. amplifier; (see Figs. 4, 5 and 7)

Anode and supply voltage	$V_b = V_a$	=	250 V
Screen grid resistor	R_{g2}	=	90 kΩ
Biasing resistor	R_k	=	325 Ω
Grid bias	V_{g1}	=	-2.5 — -39 V
Anode current	I_a	=	6 — mA
Screen grid current	I_{g2}	=	1.7 — mA
Slope	S	=	2200 — 22 μA/V
Internal resistance	R_i	=	1.1 > 10 MΩ
Equivalent noise resistance	R_{eq}	=	6.5 — kΩ
Amplification factor of the second grid with respect to the first	μ_{g2g1}	=	18 —

Operating characteristics of the EF 41 used as R.F. or I.F. amplifier; screen grid voltage of EF 41 and that of ECH 42 derived from a common potentiometer (see Figs. 2 and 10). (For details of the ECH 42 in this circuit, see page 81)

Anode and supply voltage	$V_b = V_a$	=	250	V
Resistor between supply voltage and screen grids	R_1	=	22	k Ω
Resistor between screen grids and chassis	R_2	=	27	k Ω
Biasing resistor	R_k	=	310	Ω
Grid bias	V_{g1}	=	$\overbrace{-2} \quad \overbrace{-22}$	V
Screen grid voltage	V_{g2}	=	85	135 V
Anode current	I_a	=	5.0	— mA
Screen grid current	I_{g2}	=	1.5	— mA
Slope	S	=	2000	20 μ A/V
Internal resistance	R_i	=	1.4	>10 M Ω
Equivalent noise resistance	R_{eq}	=	7.5	— k Ω
Amplification factor of second grid with respect to the first	μ_{g2g1}	=	18	—

Limiting values

Anode voltage, valve biased to cut-off	V_{a_o}	= max.	550	V
Anode voltage	V_a	= max.	300	V
Anode dissipation	W_a	= max.	2	W
Screen grid voltage, valve biased to cut-off	V_{g2_o}	= max.	550	V
Screen grid voltage, valve controlled	$V_{g2}(I_a < 3\text{mA})$	= max.	300	V
Screen grid voltage, valve uncontrolled	$V_{g2}(I_a = 6\text{mA})$	= max.	125	V
Screen grid dissipation	W_{g2}	= max.	0.3	W
Cathode current	I_k	= max.	10	mA
Grid current starting point	$V_{g1}(I_{g1} = +0.3\mu\text{A})$	= max.	-1.3	V
External resistance between first grid and cathode	R_{g1}	= max.	3	M Ω ¹⁾
External resistance between heater and cathode	R_{fk}	= max.	20	k Ω
Voltage between heater and cathode	V_{fk}	= max.	100	V

¹⁾ This value is applicable where the grid bias is obtained by means of a biasing resistor.

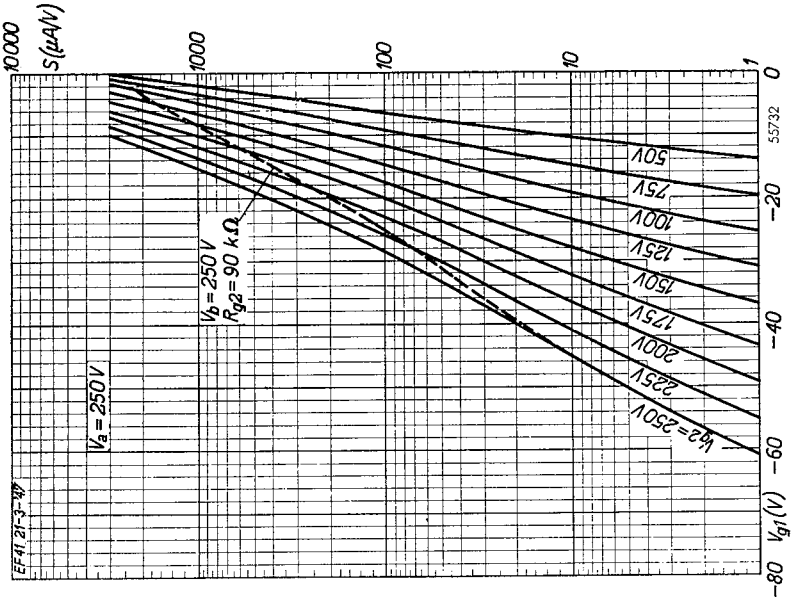

Fig. 5

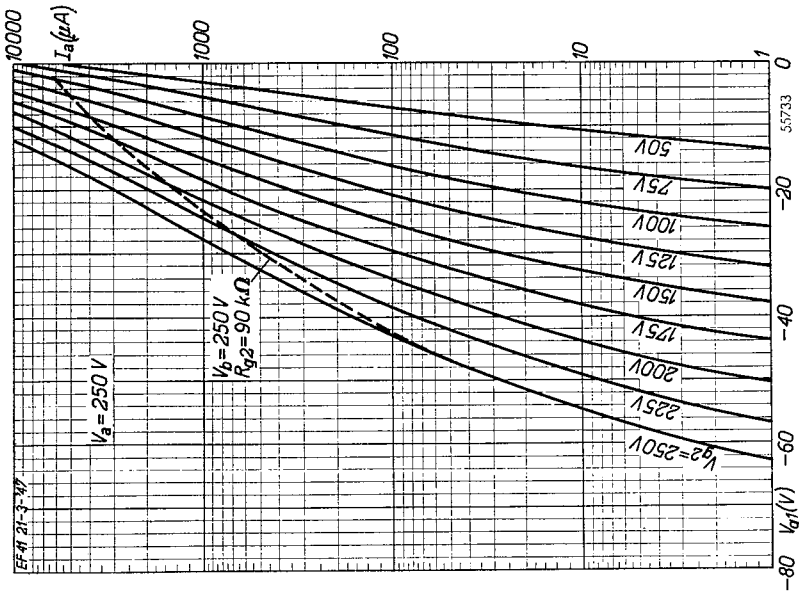

Fig. 4

Anode current I_a (Fig. 4) and slope S (Fig. 5) as functions of the grid bias V_{g1} for various values of the screen grid voltage V_{g2} . The dotted lines indicate the I_a (Fig. 4) and S (Fig. 5) when the screen grid feed is applied through a series resistor R_{g2} of 90 k Ω .

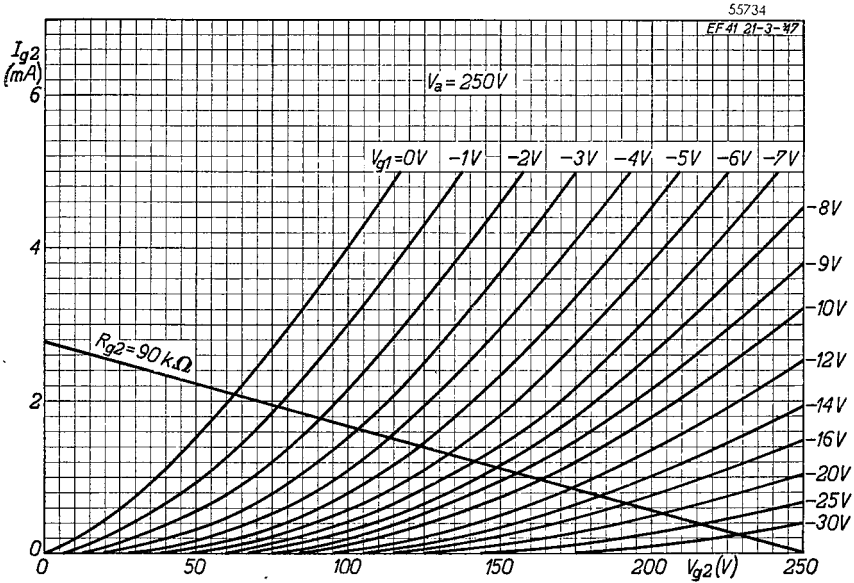

Fig. 6
Screen grid current I_{g2} as a function of the screen grid voltage V_{g2} for various values of the grid bias V_{g1} . The straight line represents the load line, with a screen grid series resistor R_{g2} of 90 kΩ.

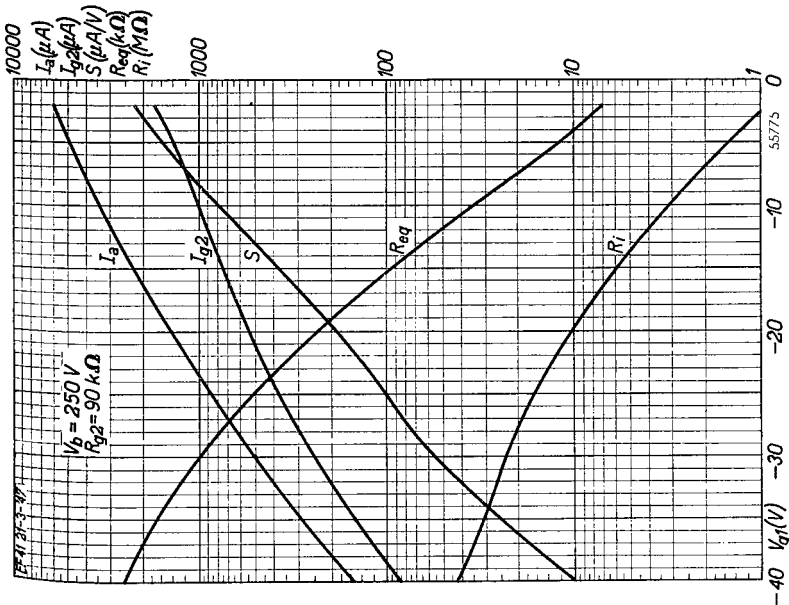

Fig. 7
Anode current I_a , screen grid current I_{g2} , slope S , internal resistance R_i , and equivalent noise resistance R_{eq} as functions of the grid bias V_{g1} with sliding screen grid voltage ($R_{g2} = 90 k\Omega$).

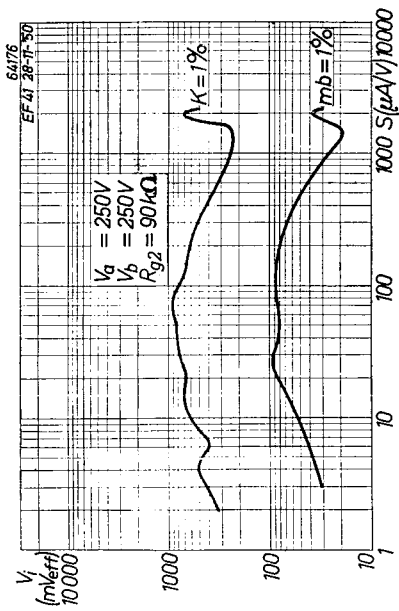

Fig. 8. The effective value V_i of an interfering signal on the control grid, producing 1% cross-modulation; also the effective value V_i of a hum signal on the control grid, producing 1% hum modulation, both as a function of the slope S .

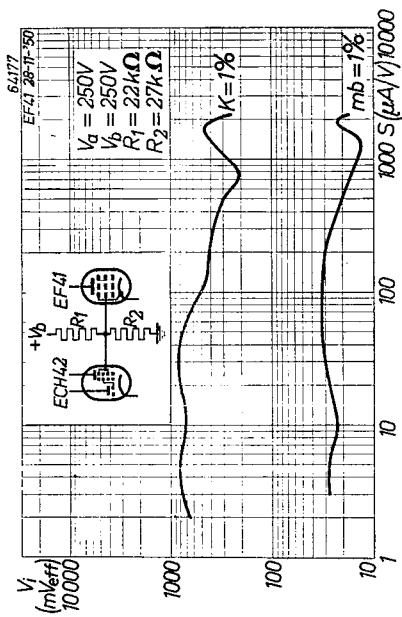

Fig. 9. As Fig. 8, with the screen grid voltage of the EF 41 and that of the ECH 42 applied by means of the same potentiometer.

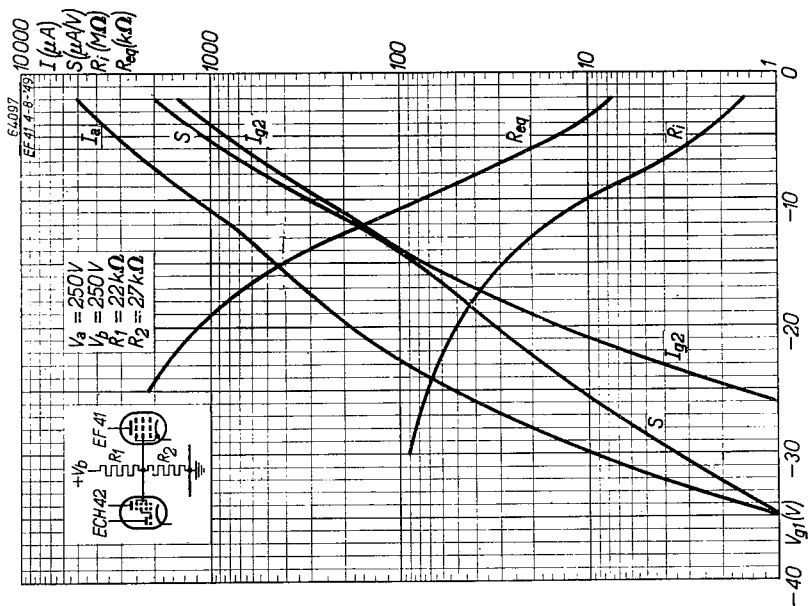

Fig. 10

As Fig. 7, but with the screen grid voltage of the EF 41 and that of the frequency changer ECH 42 applied by means of the same potentiometer.