

OPERATING INSTRUCTIONS
for
DYNAMIC MUTUAL CONDUCTANCE TUBE TESTER
MODEL 600

The Instrument Packed Herewith is: _____

1. Model 600 Vacuum Tube Tester _____

Accessories included with the Model 600 tester are:

1 -- Booklet Instructions for Model 600 _____

1 -- Grid Lead with Clip _____

Serial Number _____

Signed: _____

Instruction for operation of Model 600.

Read These Instructions Through Before Attempting to operate the Tester.

1. This instrument is designed to operate on 60 cycles 110-125 volt power source. It can be used on frequencies from 50 to 400 cycles, 110-120 volts.

2. There are two rectifier tubes, an 83 and a 5Y3GT, necessary to operate this tester. They are included. The fuse lamp is a standard #81 auto lamp. The neon lamp is a General Electric, 1/4 watt, 110 volt, candelabra base signal lamp.

3. LINE VOLTAGE ADJUSTMENT. - After the power is turned ON, press the push switch P7 which will cause the pointer of the meter to move up the scale. The button P7 is held down and the knob, LINE ADJUST, is turned until the meter pointer rests exactly over the mark, LINE TEST, at the center of the meter scale. This establishes standard voltages on the tube. Make final line adjustment after the tube being tested is placed in its socket.

4. SELECTORS. - The row of selector knobs across the center of the control panel is for the purpose of conducting proper voltages to the tube's base pins. The operation of setting these selector knobs is similar to dialing a telephone number. On the roll chart, below the word SELECTORS appear the dialing numbers. These dialing numbers consist of two letters and five figures. Example: JR-6237-5. Starting at the left, the first knob (FIL) is turned until it points at the letter J, the second knob (FIL) is turned to R, the third knob (GRID) to 6, the fourth (PLATE) to 2, the fifth

(SCREEN) to 3, the sixth (CATHODE) to 7, and the seventh (SUPPRESSOR) to 5. These selector switches are electrically interlocked so that it is impossible to connect two different voltages to the same tube pin. Thus accidental shorts are avoided.

The selector system is designed to minimize selector settings. For example the filament setting is nearly always JR. These two knobs seldom need resetting. Also in testing duo-diode-triode tubes the amount of selector setting has been reduced to a minimum.

5. SHORT TEST. - The SHORTS switch has six positions. The first five are used in testing the tube for shorts. The sixth position TUBE TEST is used when indicating mutual conductance. Use the TUBE TEST Position only if the tube has no shorts.

Turning the SHORTS switch successively through the positions 1-2-3-4-5 connects the various elements in turn across the test voltage. Tubes having shorted elements will complete the circuit and cause the neon lamp to glow. Tubes may be tested for shorts either hot or cold. A short is indicated by a steady glow on both plates of the neon lamp. A momentary flash of the neon lamp as the shorts switch is turned from one position to another should be disregarded. This flashing is caused by the charging of a condenser in the short test circuit. A shorted tube should be

discarded without further test. With tubes having more than one section such as the 6J6, make short test for each section.

Locating Shorted Elements. In the following table(X) under any SHORT switch position indicates that the neon lamp glows in that position.

KIND OF SHORT	1	2	3	4	5
FIL -- CATHODE			X		
FIL -- GRID	X	X			X
FIL -- PLATE	X	X		X	X
FIL -- SCREEN	X		X	X	X
FIL -- SUP		X			
GRID -- CATHODE	X	X	X		X
GRID -- PLATE				X	
GRID -- SCREEN		X	X	X	
GRID -- SUP	X				X
PLATE -- SCREEN		X	X		
PLATE -- SUP	X			X	X
SCREEN -- SUP	X	X	X	X	X

6. MUTUAL CONDUCTANCE. - Tubes having SHORTS should be discarded without further tests.

If the tube passes the preliminary short test it is then tested for MUTUAL CONDUCTANCE which is the best test for amplifier tubes. Turn the SHORTS switch to TUBE TEST position. On the roller chart, reading from left to right, opposite the tube type appear: FIL. VOLTAGE; SELECTORS, which were explained in paragraph (4) above; BIAS, which gives the setting for the BIAS dial; ENG, which gives the setting for the ENGLISH dial; PRESS, which indicates the push button to be pressed for meter reading; MUT-COND, which gives the AVERAGE MUTUAL CONDUCTANCE in MICROMHOS of the tube being tested. Under the heading NOTATIONS appear special notes pertaining to the testing of the tube.

The ENGLISH setting is used when it is desired to read the value of the tube on the RED-GREEN (ENGLISH) sector of the meter scale. When using the ENGLISH scale the MICROMHO readings are disregarded.

NOTE

Tubes having less than 500 Micromhos cannot be made to read in the GREEN sector of the meter scale. Such tubes list micromho reading only and are good if the reading is above a specified minimum.

Micromhos are indicated in three ranges 0-3000, 0-6000, 0-15,000.

a. On the English dial are three dots stamped into the metal and filled with red lacquer. These dots are the points used in setting the micromho ranges.

b. The dot near 73 on the dial is the setting point for the 3000 micromho scale.

c. The dot near 86 is the point for the 6000 micromho scale.

d. The dot near 92 is the point for the 15,000 micromho scale.

e. When reading micromhos the RED and GREEN sectors of the meter scale are disregarded.

f. When testing for mutual conductance the push switch P4--Gm is pressed. Gm is the symbol for mutual conductance.

CAUTION: Do not press P4 when testing rectifier tubes.

g. Tubes having more than one section, such as the 6J6, require different dial settings for each section.

7. RECTIFIER TUBE TEST. - Rectifier tubes, including diode tubes and diode sections of multiple element tubes, having no mutual conductance are tested for emission only.

a. The push switch P1 is used when testing detector diodes. It applies a low voltage which will not injure the delicate cathode. Good diodes will cause the pointer of the meter to move above the pointer marked DIODES O.K.

b. The push switch P2 is used when testing cold cathode rectifiers such as the 0Z4. This applies a voltage sufficiently high to ionize the tube and start conduction. Good tubes will read in the green (GOOD) sector of the meter scale.

c. The push switch P3 is used when testing ordinary rectifier tubes, such as the 5Y3. This applies a medium voltage which is best adapted to reveal defects in this type of tube. Good tubes will read in the green (GOOD) sector of the meter scale.

NOTE

On the data chart a star (★) following P1, P2 and P3 indicates that the ENGLISH setting only is used.

8. GAS TEST. - The push switches P5 and P6 are used to test an amplifier tube for gas content.

a. Set the English dial at 73.

b. The push switch P5 is pressed and held down while the BIAS dial is turned to cause the pointer of the meter to indicate 100 micromhos on the 0-3000 scale.

c. Hold down P5 and press P6.

d. If the tube contains gas the pointer of the meter will move UP the scale. If the pointer movement is not more than one division of the scale the gas content is satisfactory.

NOTE

With some tubes, such as the type 45, the micromho reading cannot be brought down to 100 by turning the BIAS dial. In such case turn the BIAS dial to 100 and test for gas.

a. Some tubes develop gas after being heated for a period of time. If a

tube is suspected, allow it to heat for a few minutes.

9. METER REVERSE. - Directly below the indicating meter is a switch marked REVERSE-NORMAL. With certain tubes, such as the 117N7, the meter when this switch is set on NORMAL will deflect backwards (to the left) when push switch P3 is pressed for rectifier test. In such case turn the meter switch to REVERSE which will cause the pointer of the meter to move up the scale. After the test has been made return the switch to NORMAL.

10. TOP CAPS. - There are two jacks in the upper center of the control panel marked GRID and PLATE. These are used when making connection to the top cap of the tube being tested. On the data chart in the NOTATIONS column opposite tube types having top caps is the notation CAP=G or CAP=P. G means that the top cap is connected to GRID jack and P that it is connected to the PLATE jack.

11. SOCKET NUMBERING. - In order to reduce selector set-up to a minimum, the socket contacts are numbered as shown on Plate 1 which shows the bottom views. The numerical values of the lettered dials as follows:

0	----	A	----	P
1	----	B	----	R
2	----	C	----	S
3	----	D	----	T
4	----	E	----	U
5	----	F	----	V
6	----	G	----	W
7	----	H	----	X
8	----	J	----	Y
9	----	K	----	Z

The letter I was omitted because of its resemblance to the figure 1. The letter Q was omitted because of its resemblance to the figure 0.

SOCKET NUMBERING BOTTOM VIEWS

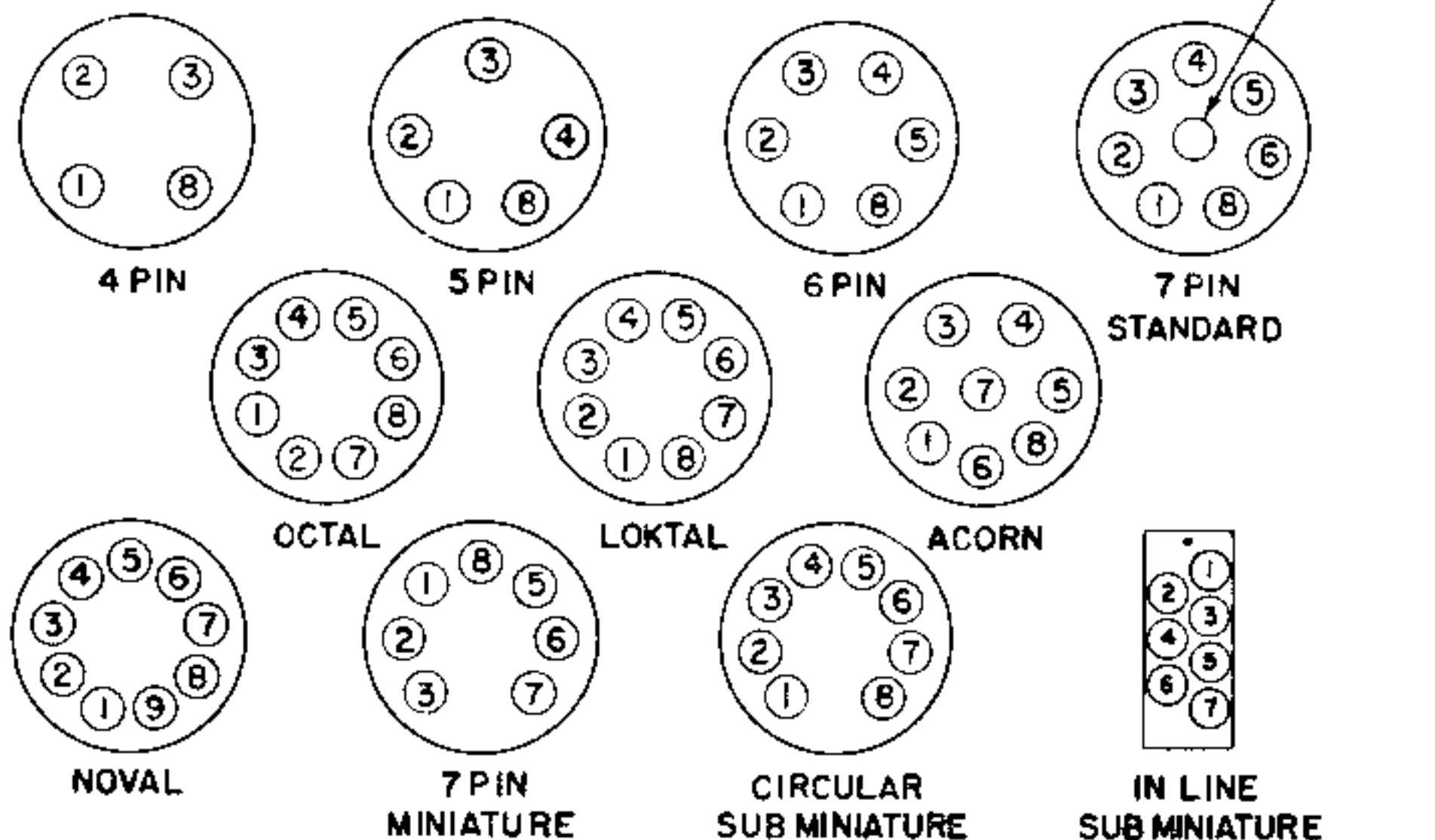

NOTE

The center of the large 7-pin socket is used to check pilot lamps. Set the filament selector switches on JR. Set the filament voltage switch to the proper voltage for the lamp being tested.

12. SPECIAL NOTES.— Power line voltage varies with different localities. It may also vary with different hours of the day.

While a national survey indicates that the average voltage for the USA is about 117 volts, it does not mean that every locality maintains a constant voltage at that level.

Occasionally we have had the complaint that a used tube will test GOOD, but will not work in the radio receiver; but when a NEW tube is substituted, the receiver will operate correctly. The answer is this; Tubes are built to specifications. Our tube testers are designed to test tubes in conformity with these specifications.

The used tube that would not per-

form in a certain receiver was not receiving its specified filament voltage. The new tube performed because of its initial reserve capacity. The used tube would have performed if it had received its specified filament voltage.

Tube failure frequently occurs in A.C.--D.C. sets where several tubes are connected with their heaters or filaments in series. Sometimes, even though the power line voltage is normal, a series tube with abnormally high filament resistance will rob its companion tube of its normal filament voltage. The robbed tube apparently fails; but when tested under specified conditions, the tube will test GOOD.

13. The versatility of the Hickok Dynamic Mutual Conductance Tube Tester makes possible a special test that will reveal a tube's ability to perform under adverse conditions as mentioned above. This is possible because the tester measures mutual conductance instead of emission.

THE TEST

a. Measure the mutual conductance in the ordinary way.

b. Press P4 and adjust the ENGLISH dial until the tube reads in the GREEN (GOOD) sector at 2000 on the 0-3000 scale.

c. While holding everything else constant, reduce the FILAMENT voltage and note new reading.

d. If the meter still reads in the GREEN (GOOD) sector, the tube has a large life reserve and will perform satisfactorily.

e. The filament voltage reductions to be made are shown in the following table:

<u>NORMAL FIL. VOLTS</u>	<u>REDUCE TO</u>
1.5	1.1
2.0	1.5
2.5	2.0
3.0	2.5
5.0	4.3
6.3	5.0
7.5	6.3
10.0	7.5
12.6	10.0
35.0	25.0
50.0	35.0

14. CONTINUITY TEST. - The Model 600 Tube Tester can be used to test for continuity through resistances up to 200,000 ohms.

a. Set SHORTS switch on position 4.
b. Connect two leads having prods and pin tips to the jacks marked PLATE and GRID.

c. Touch the prods to the terminals through which continuity is to be determined.

d. The neon lamp will glow if circuit is continuous.

15. FILAMENT AND HEATER CONTINUITY.

1. Turn tester on.
2. Set selectors as per chart for tube to be tested.
3. Set FILAMENT switch on HLST instead of voltage indicated on chart.
4. Set SHORT TEST switch on position 1.
5. Place tube in proper socket.

If the neon lamp glows, the filament is good and a complete test should then be made on the tube, by setting FILAMENT switch on the proper tap, and while the tube heats, rotate the SHORT TEST switch several times thru all positions. If no shorts are indicated, set the switch in TUBE TEST position and proceed to test the tube as per chart.

If the neon lamp does not glow, filament is open and further test is unnecessary. Certain tubes such as the 35Z5-50Z7, etc. with tapped filaments have special continuity test settings, see roll chart.

TO TEST BALLAST TUBES

1. Turn Tester on.
2. Set filament switch to BLST.
3. Set SHORT TEST switch on 1.
4. Set first selector switch (lettered A to K) to letter shown in column marked (first selector) -- Set all numbered selectors on zero --
5. ROTATE second selector switch (lettered P to Z) from P to Z. NEON LAMP SHOULD LIGHT IN POSITIONS NOTED.

TUBE TYPE	First Selector	Neon lamp should light in these positions.					
		R		T			X
1A1-1B1-1C1-1E1-1F1-1G1-1J1-1K1-1L1-1N1-1P1-1Q1-1R1G-1S1G-1T1G-1U1G-1V1-1Y1-1Z1-2	J	R					
2UR224	J			T			X
2LR212	H	R	S		U		

PARTS LIST FOR MODEL 600 TUBE TESTER

NOTE: There is a minimum charge of \$1.50 for any parts order.

HICKOK CODE NO.	NAME AND DESCRIPTION	REF. SYMBOL OR FUNCTION
2490-156	BOOKLET, Instruction	
2920-7	BUTTON, Push: black	
2920-8	BUTTON, Push: red	
3095-41	CAPACITOR: 2700 mmf, 500 V, 10%, mica	C2
3105-24	CAPACITOR: .1 mfd, 400 V, paper	C1
3200-44	CHART, Roll: tube data	
4160-67	DIAL Ass'y: Bias	
4160-73	DIAL Ass'y: English	
10300-1	JACK, Pin: red, Eby #52	
10300-2	JACK, Pin: black, Eby #52	
11500-11	KNOB, Ass'y: Hickok bar knob with pointer	
12270-1	LAMP: neon glow, 1/4 W, 115 V.	
12270-2	LAMP: auto, Tung-Sol #81, bayonet type	
12270-12	LAMP: #47 G.E., 6-8 V, .15 amp, miniature bayonet base	PILOT
12270-17	LAMP: #49 pilot, .06 mils, 2V, bayonet	
12450-145	LEAD, Ass'y:	
12450-180	LEAD, Ass'y: Grid cap, Amphenol #63-1W	
12450-207	LEAD, Ass'y:	
480-781	METER: DC milliammeter, S48 black, flush square	
16925-90	POTENTIOMETER: dual, 150-150 ohms, linear, wire wound, Mellory #MM15CP	R4, R5
16927-5	POTENTIOMETER, Ass'y: 3000 ohms	BIAS, R7
18410-472	RESISTOR: 47 ohms, 1/2 W, 10%, fixed, comp.	R20, R21, R22
18413-271	RESISTOR: 27,000 ohms, 1/2 W, 5%, fixed, comp.	R15
18413-471	RESISTOR: 47,000 ohms, 1/2 W, 5%, fixed, comp.	R23
18414-182	RESISTOR: 180,000 ohms, 1/2 W, 10%, fixed, comp.	R8
18414-332	RESISTOR: 330,000 ohms, 1/2 W, 10%, fixed, comp.	R10
18415-102	RESISTOR: 1 meg, 1/2 W, 10%, fixed, comp.	R17
18422-122	RESISTOR: 1200 ohms, 1W, 10%, fixed, composition	R2
18423-151	RESISTOR: 15,000 ohms, 1W, 5%, fixed, comp.	R3, R23
18550-89	RESISTOR: 215,000 ohms, 1W, 1%, Wilkor CP1	R24
18575-12	RESISTOR: 1800 ohms, 10 W, 10%, fixed, vitreous enamel	R1
18575-19	RESISTOR: 100 ohms, 10%, vitreous enamel, center-tapped	R12, R13
18575-89	RESISTOR: 8500 ohms, 10W, 10%, wire wound	R6
18670-406	RESISTOR, Spool: medium, 15 ohms	R9
18670-418	RESISTOR, Spool: medium, 150 ohms	R14
18750-2	RHEOSTAT: 200 ohms, 25 W, Mod. D, Ohmite #2878-3SC	R16
19350-1	SOCKET: small bayonet, Drake #614L-CH-LT	
19350-2	SOCKET: candelabra, Drake #414-14L-LT	
19350-62	SOCKET: 9-pin, black, Cinch Mfg.	
19350-76	SOCKET: 7-pin miniature, Amphenol #147-170-24	
19350-77	SOCKET: 8-pin octal, black, Amphenol #77-MIP-8	
19350-78	SOCKET: 4-pin, black, Amphenol #77-MIP-4	
19350-93	SOCKET: 4-pin, black, Amphenol #78S-4	
19350-94	SOCKET: 5-pin, Amphenol #78S-5	
19350-95	SOCKET: 6-pin, Amphenol #78S-6	
19350-96	SOCKET: 7-pin, Amphenol #78-7CD	

Prices will be furnished upon request.

PARTS LIST FOR MODEL 600 TUBE TESTER

NOTE: There is a minimum charge of \$1.50 for any parts order.

HICKOK CODE NO.	NAME AND DESCRIPTION	REF. SYMBOL OR FUNCTION
19350-97	SOCKET: 8-pin loctal, Amphenol #78-8I	
19350-99	SOCKET: 8-pin octal, Amphenol #78S-8	
19350-101	SOCKET: sub-miniature, Cinch #EXP-8694	
19350-112	SOCKET, Ass'y: Drake #40	PILOT
19350-119	SOCKET: sub-miniature, 7-contact, Cinch #EXP-8736-B1	IN-LINE
19910-54	SWITCH: Push button, 7-gang, Oak #43927-130	F1-F7
19911-7	SWITCH: Snap EPDT, Oak #16743-78	METER REVERSING
19911-9	SWITCH: Toggle, SPST, A.E. & H. #20994-DA, with bat handle	
19912-202	SWITCH: Rotary, 1 section, 2 pole, 20 position	OFF-ON
19912-203	SWITCH: Rotary, 5 section, 6 position, Oak Type F	FILAMENT
19912-204	SWITCH: Rotary, 5 section, 10 position, Oak Type F	SHORT TEST
19912-205	SWITCH: Rotary, 1 section, 10 position, Oak Type F	SELECTORS
		CATHODE- SUPPRESSOR
20800-1Q1	TRANSFORMER: Power	
20875-6	TUBE: 5Y3GT/G	RECTIFIER
20875-28	TUBE: 83	RECTIFIER

NOTE

In ordering parts or materials for this instrument, the serial number must be given in order to identify properly the material required.

Prices will be furnished upon request.

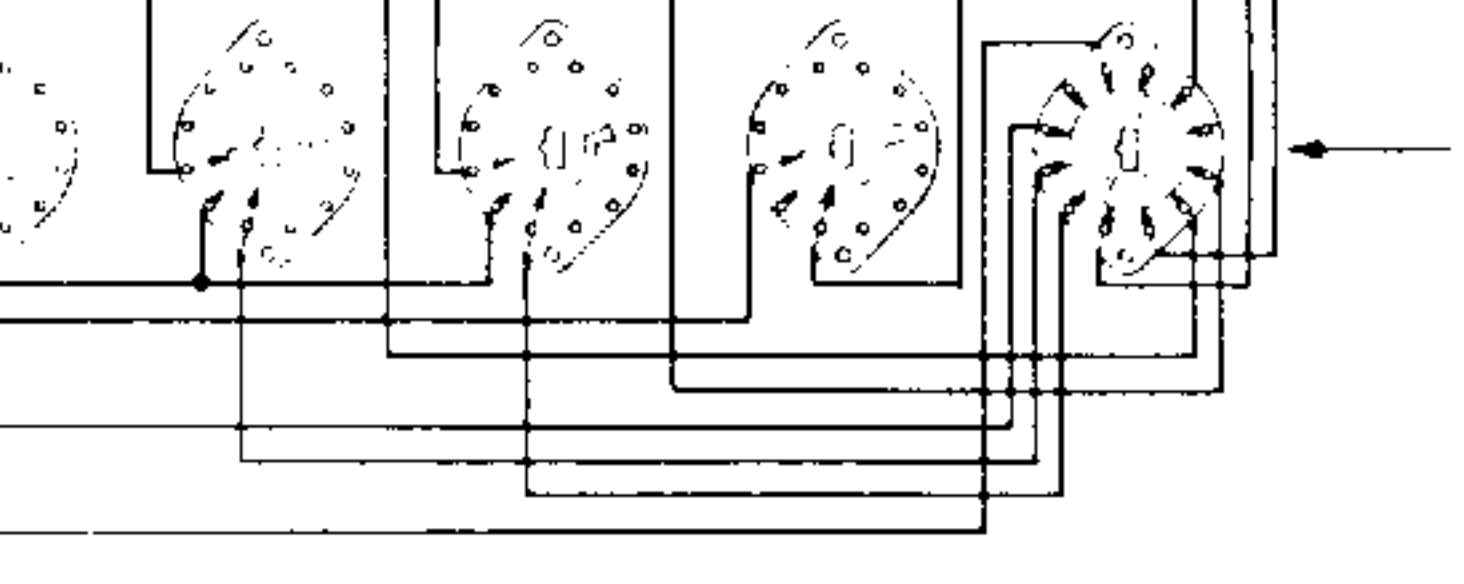
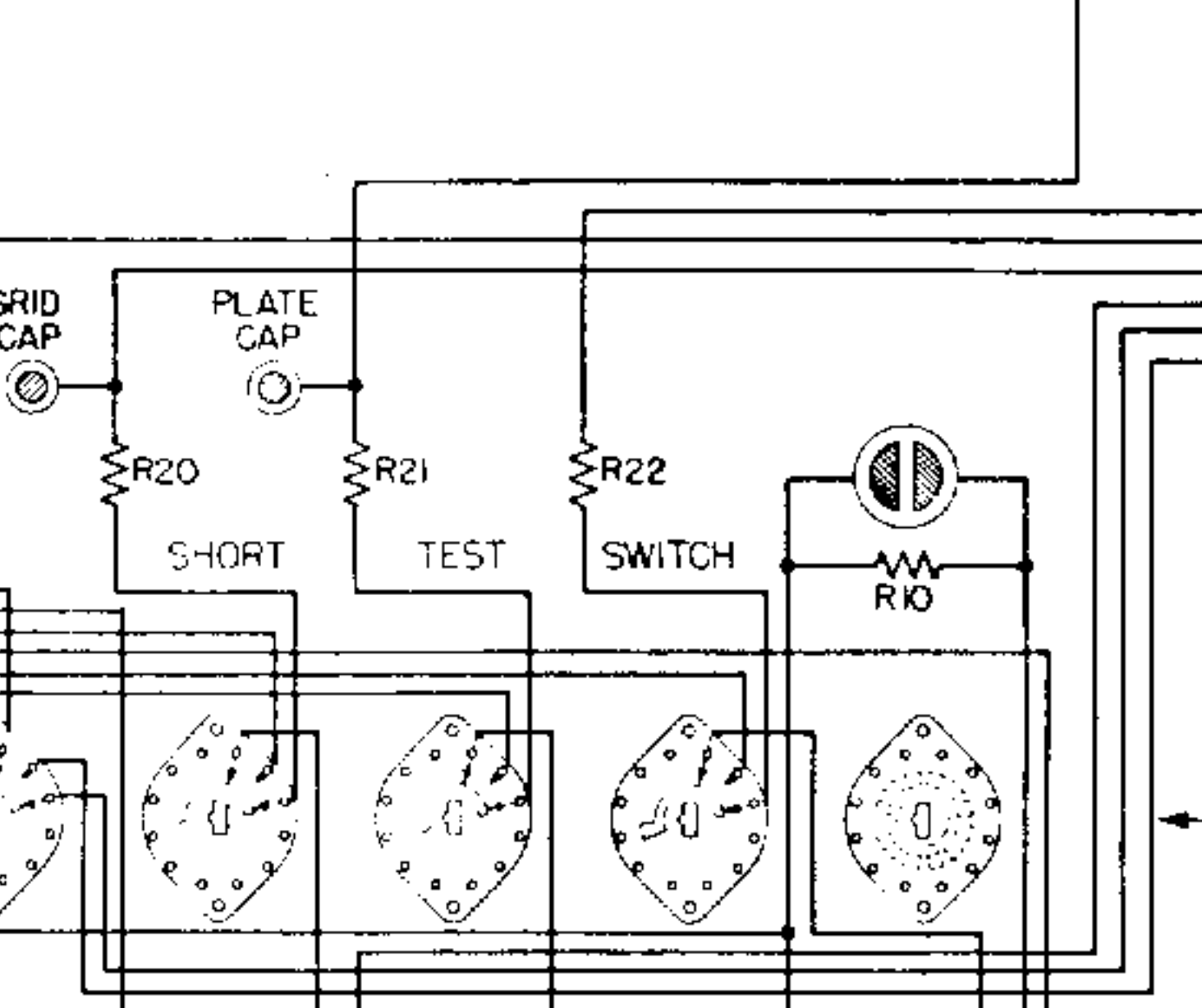
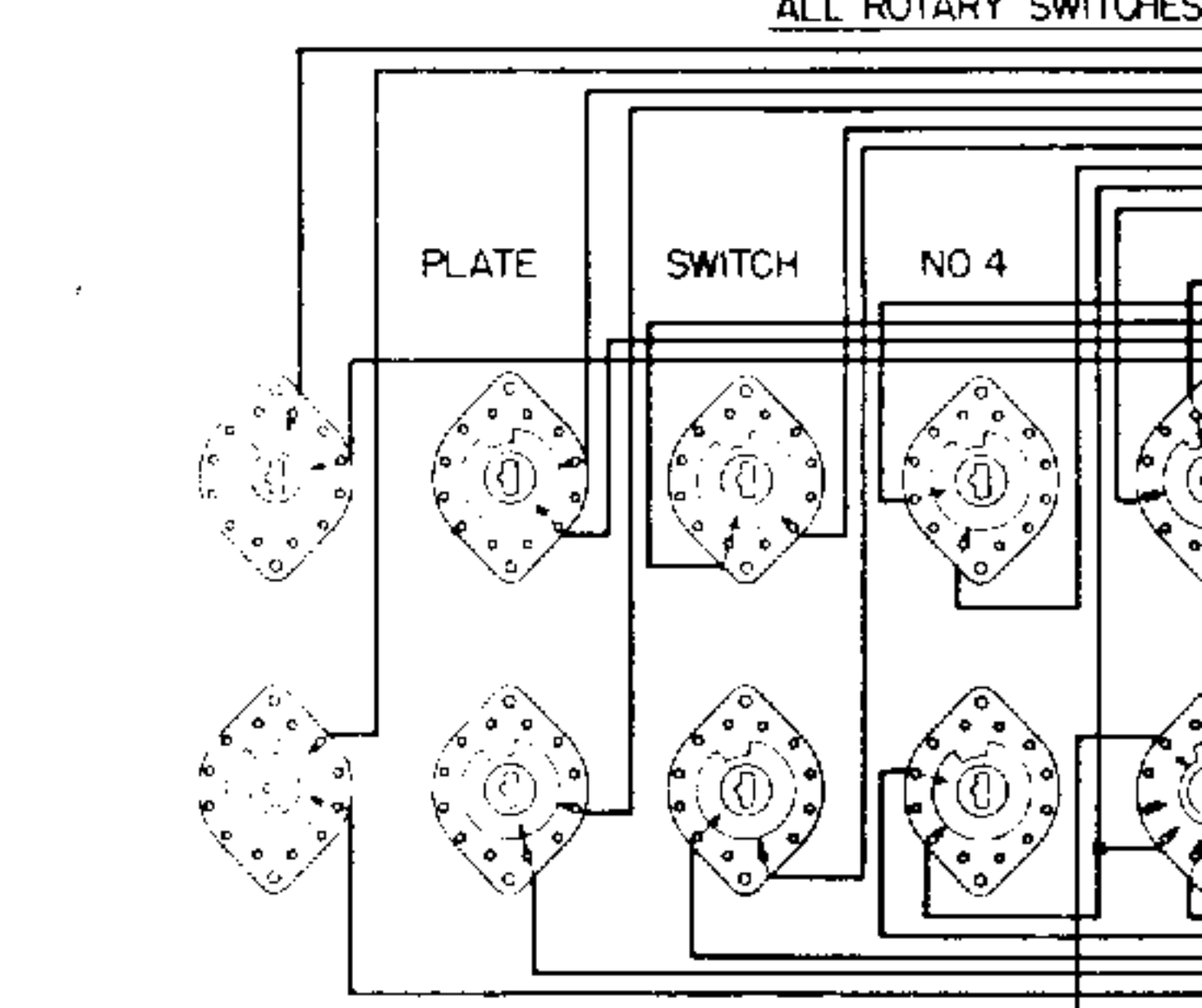
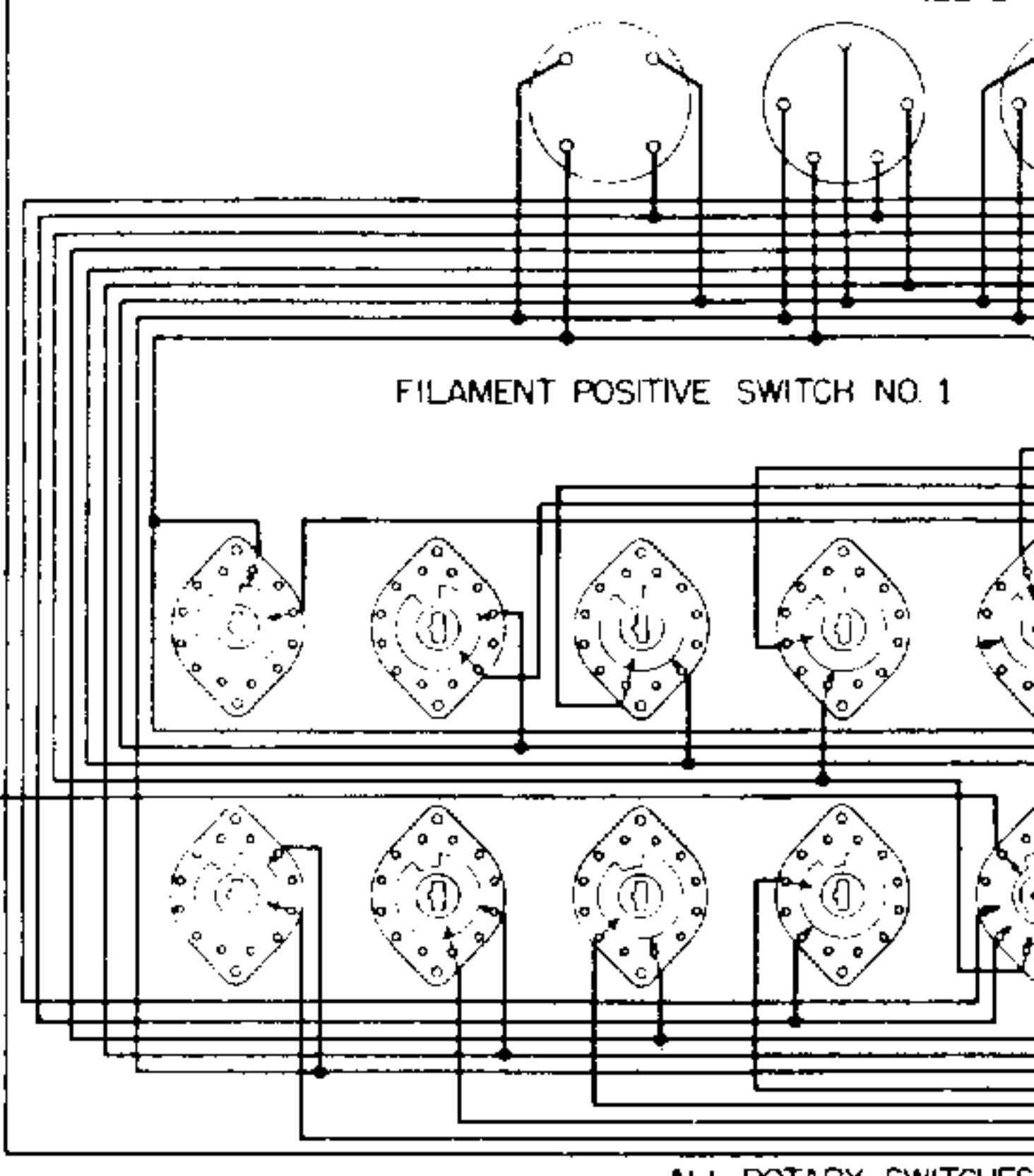
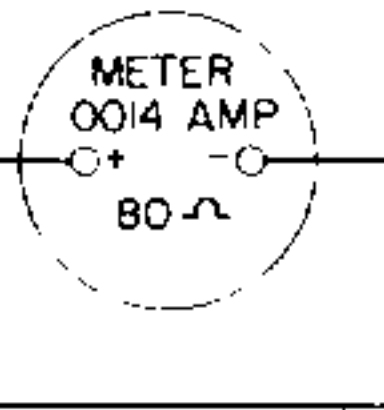
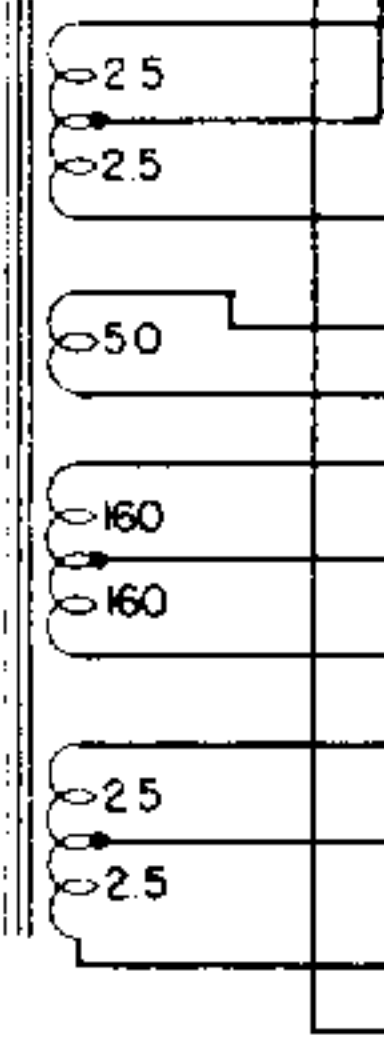
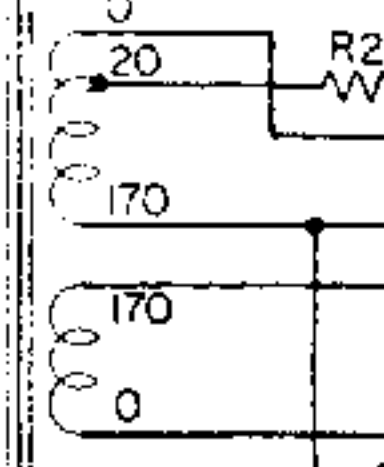
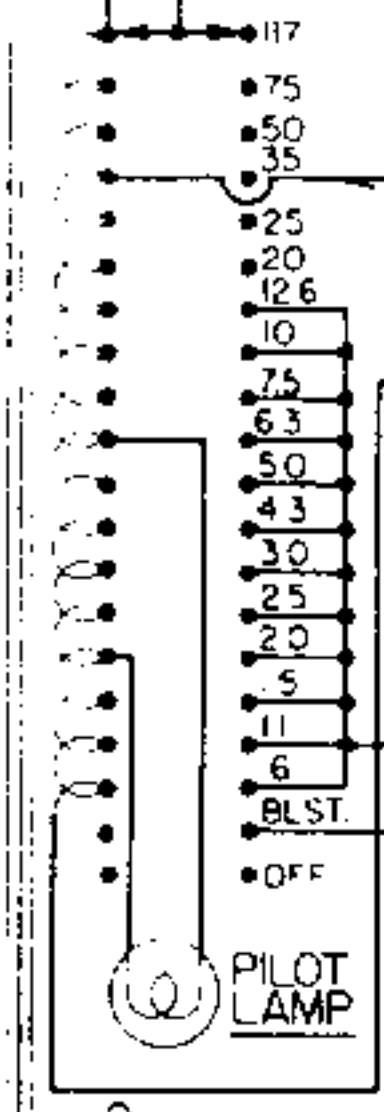
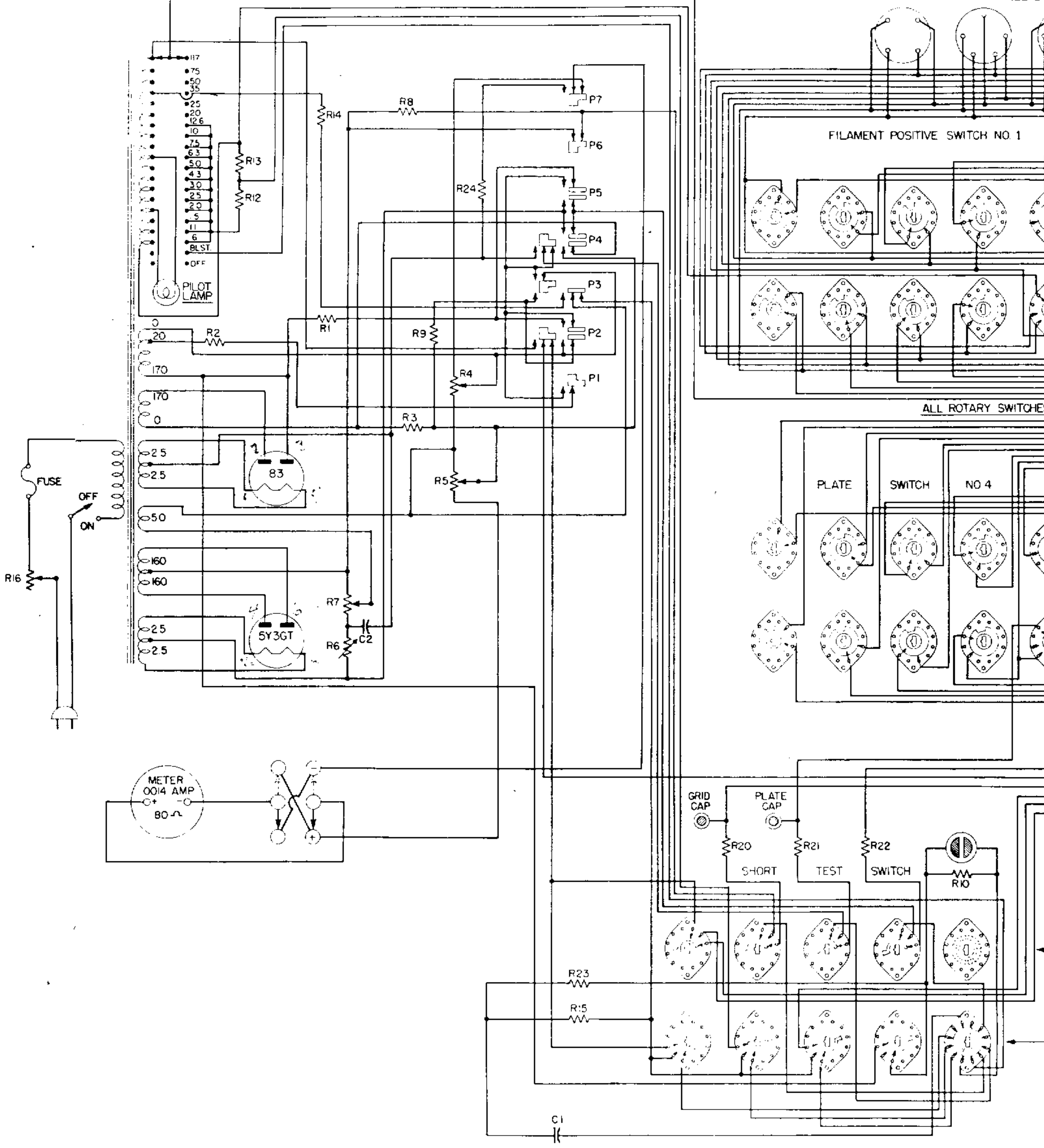

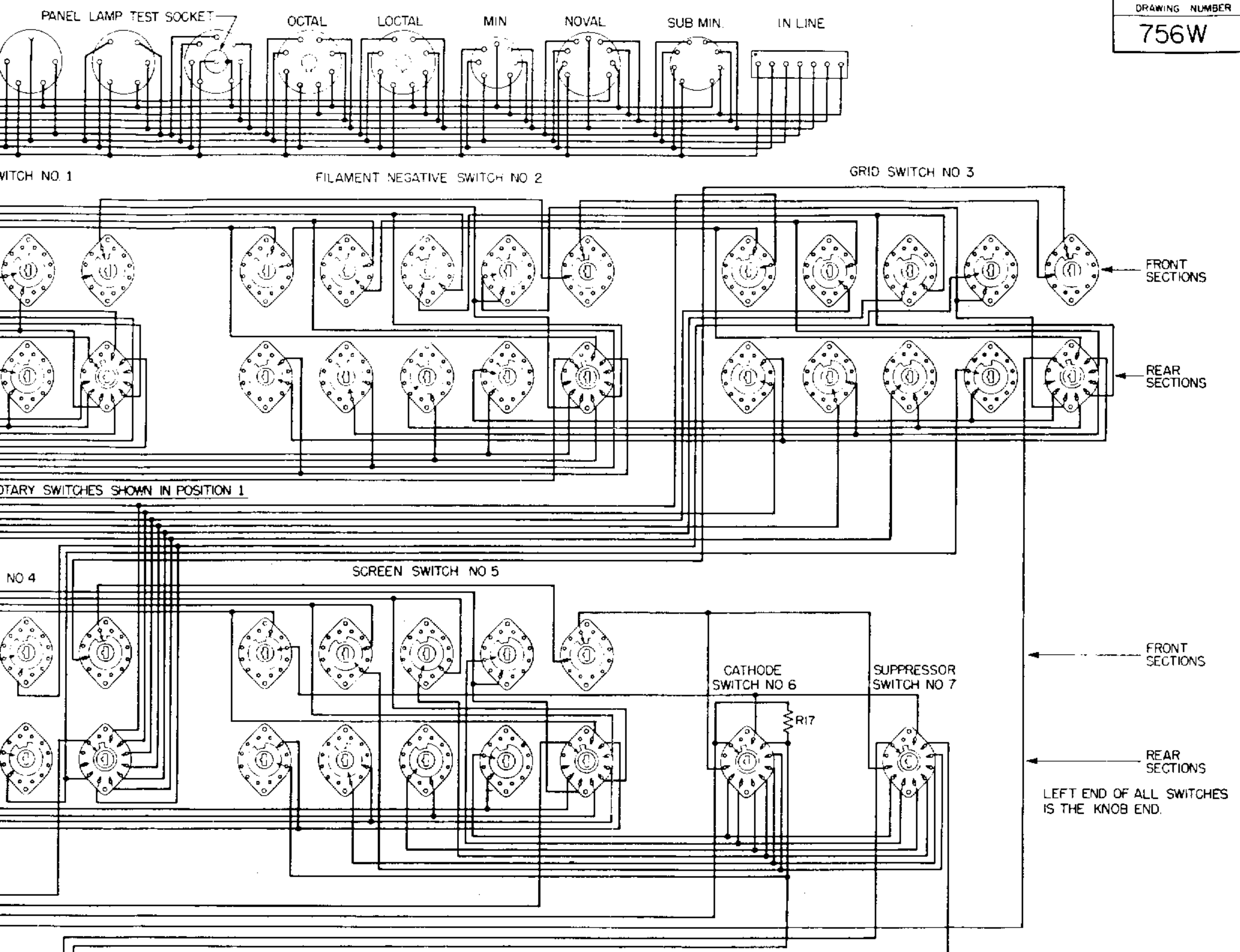

R1	1800 Ω	R14	150 Ω
R2	1200 Ω	R15	27,000 Ω
R3	15000 Ω	R16	200 Ω
R4	150 Ω DUAL POT.	R17	1 MEG.
R5	150 Ω	R20	47 Ω
R6	8500 Ω ADJUST	R21	47 Ω
R7	3000 Ω POT.	R22	47 Ω
R8	180,000 Ω	R23	47,000 Ω
R9	20 Ω	R24	215,000 Ω
R10	330,000 Ω	C1	1 MFD-400V
R12	50 Ω	C2	0027-1000 V.
R13	50 Ω		

SCHMATIC
MODEL 600 TUBE TESTER

MADE BY
THE HICKOK ELECTRICAL INSTRUMENT COMPANY
CLEVELAND, OHIO

SCHEMATIC WIRING DIAGRAM			
USED ON MODEL 600 TUBE TESTER			DATE 8-24-50
DRAWN	CHECKED	APPROVED	DRAWING NUMBER
21K		JRB	756W